



The benefits of using the Electrical toolset in AutoCAD



Introduction

Built specifically to create and modify electrical control designs, the Electrical toolset (previously referred to as AutoCAD Electrical) is now included as part of the AutoCAD including specialized toolsets offering Purpose-built electrical design tools that help eliminate errors and provide accurate information to manufacturing allow more time for design and engineering. This study details the productivity gains that users may experience when using AutoCAD with the Electrical toolset rather than just basic AutoCAD.*

Executive summary

Designed by Autodesk and commissioned to an independent consultant, this study explores ten common design challenges and shows direct comparisons of the time and effort required to accomplish each specific task with basic AutoCAD and AutoCAD with the Electrical toolset. The same tasks were completed up to **95%* faster** on average using the Electrical toolset (depending on user expertise level with the Electrical toolset software and based on experience and training).

Key findings

Using the Electrical toolset:



Faster

Creating new designs was **84%** faster.

Editing existing designs was **77%** faster.

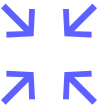

Reduced

Risk of errors was greatly reduced because of a **67%** reduction in number of commands used.

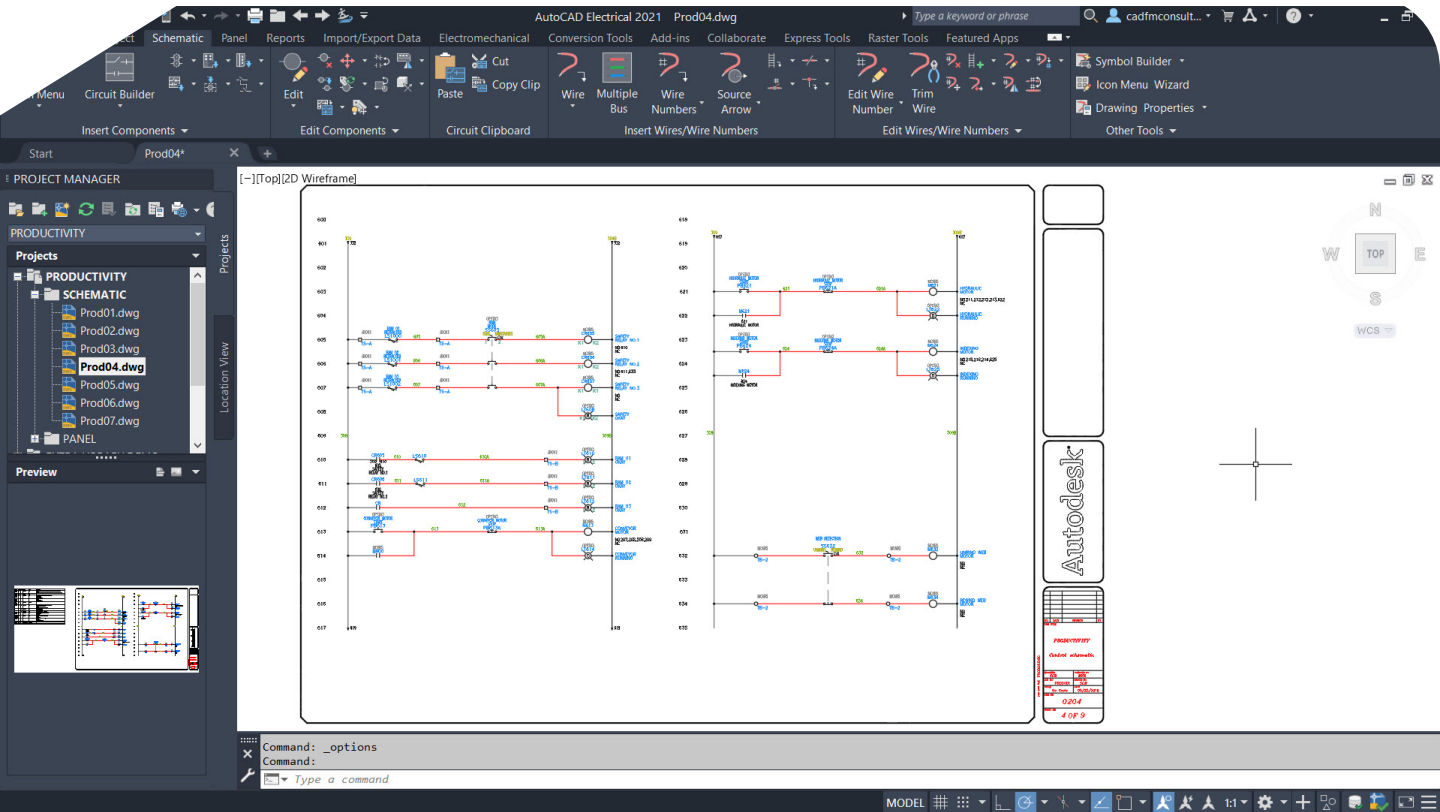

The study

This study explores ten common design challenges and shows direct comparisons of the time and effort required to accomplish each specific task in basic AutoCAD versus with the Electrical toolset.*

The same tasks were completed up to **95% faster** on average using the Electrical toolset.*

The performance results in this paper were achieved by one expert-level user using both basic AutoCAD and AutoCAD with the Electrical toolset. This user conducted the comparative tests on the same sample Electrical toolset drawings in the same project. The tasks are comprehensive in nature. For each task, the number of commands used, number of times each command was accessed, and the total time it took to complete each task using both basic AutoCAD and AutoCAD with the Electrical toolset are documented in each case.

It was assumed during the study that all symbols and title blocks needed in basic AutoCAD for the design process were local to the document. Searching time is subjective and the methodologies allowed for the quick placement of required blocks in the shortest amount of time possible.

Design task 1

Comprehensive symbol libraries

The Electrical toolset comes with more than 2,000 standards-based schematic symbols. A simple, icon-menu-driven system for inserting electrical, pneumatic, hydraulic, and P&ID devices is provided, allowing you to quickly build standards-based control designs with a simple pick-and-place workflow.

These are smart symbols in many ways, one of which is that wiring automatically breaks and connects to them.

In this task, two Normally Open (NO) limit switches will be inserted into an existing electrical schematic next to two relay coil symbols that are tied into a conveyor start motor circuit. The task is to add two more interlock symbols to the already existing circuit, utilizing the Icon Menu in the Electrical toolset.

Steps

1. Insert limit switch contact into an existing wire
2. Add new wire numbers and switch numbers as required

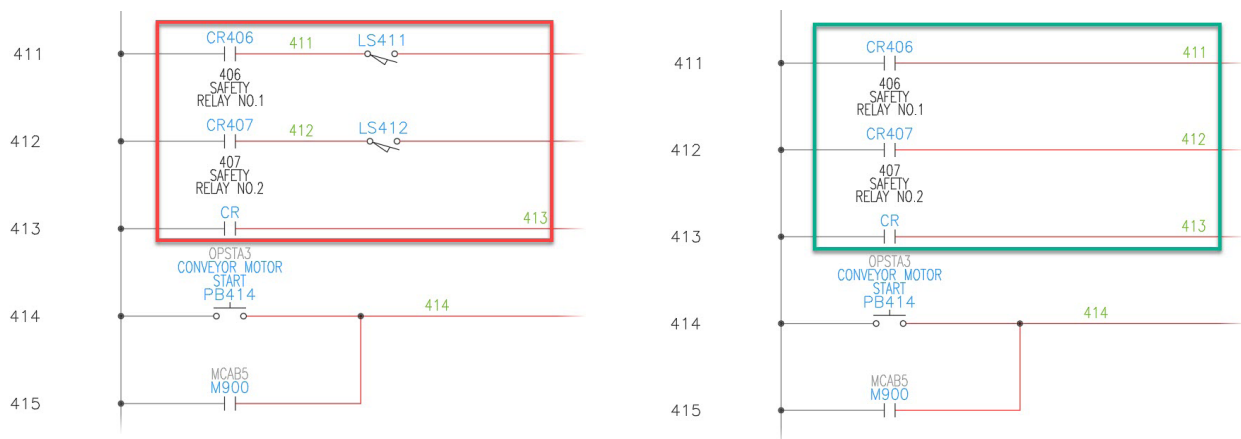

Comprehensive symbol libraries	AutoCAD	Electrical toolset
Number of commands utilized	4	1
Number of times commands accessed	8	2
Number of user picks and clicks	48	10
Total time to complete task	1:50	0:16
Time savings with the Electrical toolset		85%

(Figures shown in minutes and seconds)

Advantages

The Electrical toolset provides smart schematic symbols (not just regular AutoCAD blocks) that align with the wires in the schematic drawing and renumber where applicable. In basic AutoCAD, the blocks had to be moved and rotated to align with the wires, and wire numbers needed to be moved manually.

- The Icon Menu provides an extensive library of component symbols that are easy to use, colorful, and customizable
- Inserted component symbols automatically align with any underlying wire
- Existing wiring automatically breaks and reconnects to symbols
- New, unique wire number assignments automatically generate for split wire pieces
- When an electrical drawing created in the Electrical toolset is opened in basic AutoCAD, Blocks palette with block libraries functionality can be utilized. However, the Icon Menu is the preferred workflow in the Electrical toolset as it provides much greater time savings.

Design task 2

Automatic wire numbering and component tagging

The Electrical toolset automatically places sequential or reference-based numbers on all wires and components based on the chosen configuration.

The Electrical toolset can also determine if an inserted wire will “bump” into anything and automatically searches laterally along the wire for a clear spot to place the wire number. If no clear spot is found, the Electrical toolset will find a spot away from the wire and draw a leader back to the wire.

In this task, the circuit needs to be updated to reflect a numbering scheme change for an existing design. The task is to completely retag the drawing with unique reference numbers, component tags, and wire numbers.

Steps:

- Change starting ladder reference numbers
- Re-tag all schematic symbols based upon the new line reference numbers
- Reassign wire numbers sequentially, starting with the wire number tags

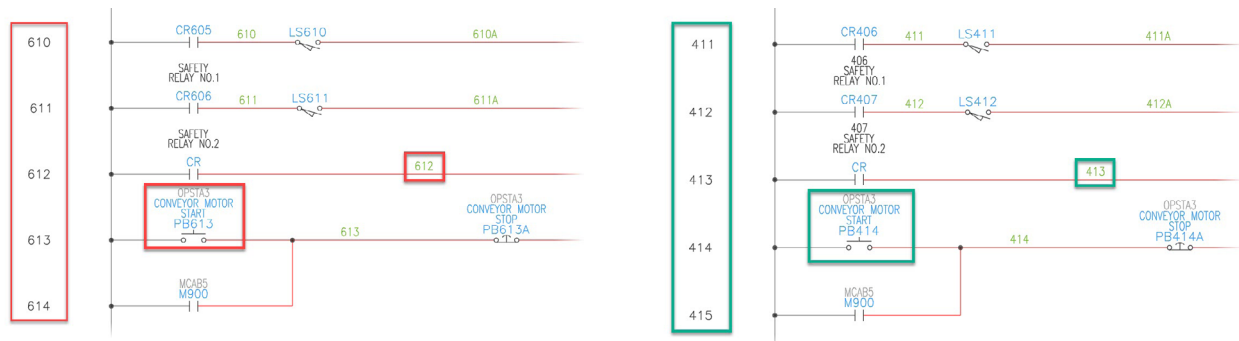

Automatic wire numbering and component tagging	AutoCAD	Electrical toolset
Number of commands utilized	2	3
Number of times commands accessed	17	3
Number of user picks and clicks	91	14
Total time to complete task	1:50	0:20
Time savings with the Electrical toolset		82%

(Figures shown in minutes and seconds)

Advantages

The Electrical toolset can save vast amounts of tedious editing time that would be needed in AutoCAD, and it provides additional options over basic AutoCAD software for schematic numbering.

- The next unused wire number is determined automatically, even across dozens of drawings
- New, unique component tags/IDs are automatically generated and appropriate to component type
- Automatic component and wire number tags can be reference-based or sequential
- Wire numbering and component tagging can be applied either drawing- or project-wide



Design task 3

Real-time error checking

The Electrical toolset includes real-time error checking to help you avoid errors during the design process. It compares any requested changes with the current project and alerts you to duplicated schematic component reference designations, wire numbers, and more.

The task, in this case, demonstrates automatic contact pin assignment and contact count checking when linking child relay contact symbols to parent relay coil symbols, assigning the next available set of contact pin numbers based upon the catalog number assignment.

Steps:

- Using a relay coil that has a catalog assignment that corresponds to having four child contacts. Scanning the project to find instances of child contacts in other views on other drawings.
- Relating other child contacts, located on another project drawing, back to the relay coil
- Assigning the next available contact pin number pairs based on the coil's catalog number assignment

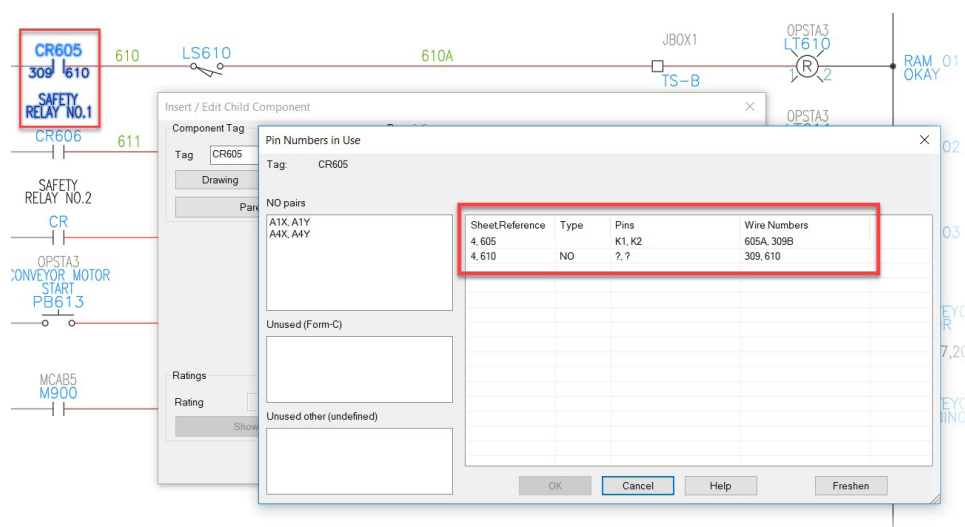

Real-time error checking	AutoCAD	Electrical toolset
Number of commands utilized	2	2
Number of times commands accessed	5	3
Number of user picks and clicks	114	18
Total time to complete task	2:15	0:23
Time savings with the Electrical toolset		83%

(Figures shown in minutes and seconds)

Advantages

The Electrical toolset provides the following advantages for real-time error checking:

- Automatically finds the next available pin pair for each child contact
- Pulls in a simple pick from a 'parent' list, tag/ID, and description and assigns cross-references
- Alerts when the maximum contact count is exceeded on any smart component
- Avoids costly errors

Design task 4

Real-time coil and contact cross-referencing

The Electrical toolset sets up parent/child relationships between component symbols, even if they are on different project drawings.

It also keeps track of how many contacts are assigned and alerts users when the limits are exceeded. The task is to tie a relay contact to a relay coil when the coil is on a different drawing and to show the appropriate bi-direction, cross-reference annotation in a tabular format.

Steps:

- Open a second drawing of a multi-drawing project and insert two relay contact symbols
- Tie each relay contact to a parent coil symbol on the first drawing in the contact set
- Update cross-reference information on both the child contact symbol and the parent coil symbol

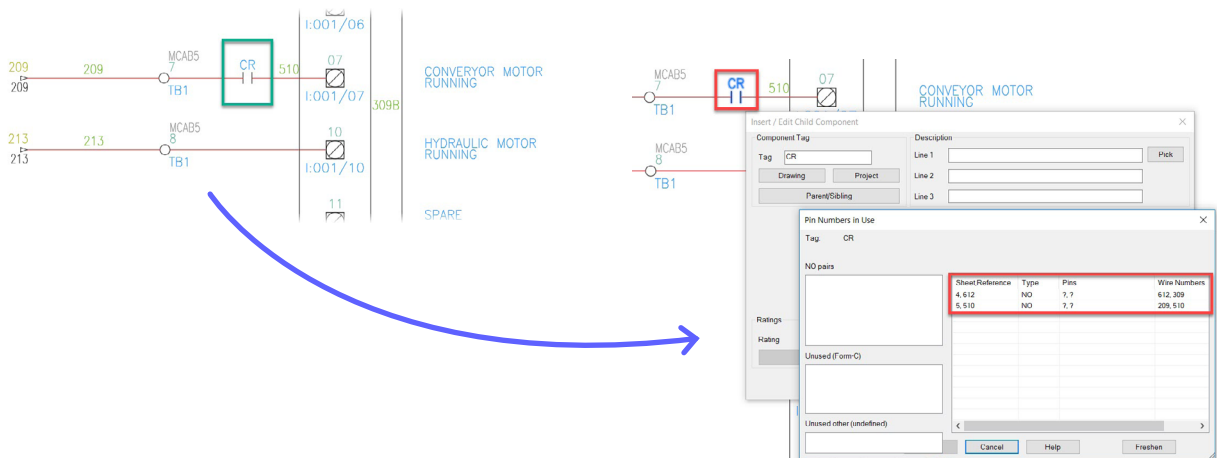

Real-time coil & contact referencing	AutoCAD	Electrical toolset
Number of commands utilized	5	1
Number of times commands accessed	8	2
Number of user picks and clicks	82	4
Total time to complete task	1:55	0:26
Time savings with the Electrical toolset		77%

(Figures shown in minutes and seconds)

Advantages

The Electrical toolset offers huge time savings here because:

- It tracks contact usage over all project drawings so you don't have to track it
- Selection is simple from a real-time list of parent relays with error checking, auto-pin list assignment, and auto-tagging
- Bi-directional, cross-referencing updates automatically, even with complex formats



Design task 5

Electrical-specific drafting features

The Electrical toolset offers many commands designed specifically for electrical schematic drafting. Specialized features such as Trim Wire, Scoot, and Align Components make it easier to create drawings quickly, especially using the Marking Menu.

Steps:

- Add multiple-bus wiring to a three-phase circuit drawing
- Insert a three-phase motor with automatic connections and fuses
- Add and/or scoot wire numbers and components when editing
- Adjust wire crossings to keep drawing organized and ensure wires are clearly visible

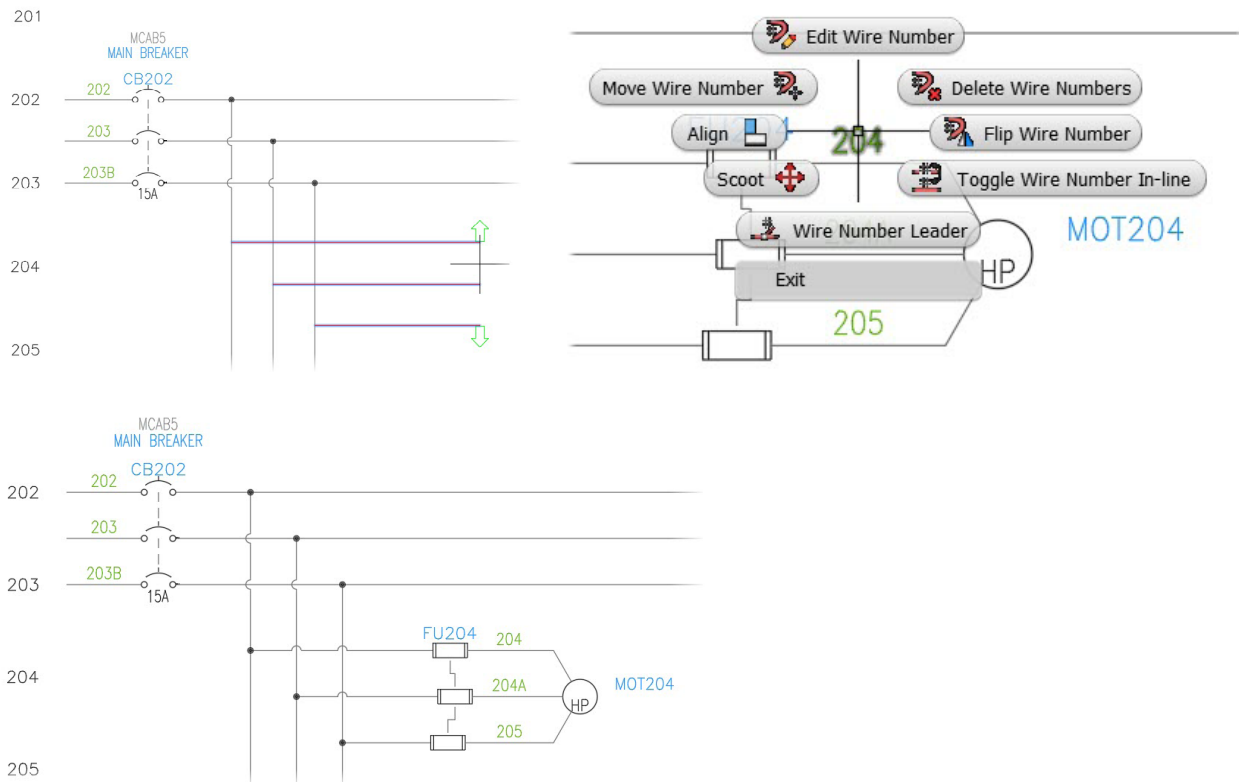

Electrical-specific drafting features	AutoCAD	Electrical toolset
Number of commands utilized	6	5
Number of times commands accessed	22	7
Number of user picks and clicks	112	44
Total time to complete task	4:45	1:45
Time savings with the Electrical toolset		63%

(Figures shown in minutes and seconds)

Advantages:

- Intelligent point-to-point wiring tools
- Automatic wire connections with no OSNAP mode required
- Connectors align with underlying wiring
- The Scoot command enables quick adjustment to wire and component positions

Design task 6

Automatically create PLC I/O drawings from spreadsheets

The Electrical toolset provides users with the ability to create PLC I/O drawings from spreadsheets (such as Microsoft® Excel). All the necessary I/O assignments and connected devices are included in the spreadsheet file, which the Electrical toolset converts into a PLC I/O drawing using the PLC I/O Utility.

The task is to use the Electrical toolset, bring in the PLC I/O spreadsheet, and run the PLC I/O Utility to create the PLC I/O drawing. In basic AutoCAD, it is assumed that all the necessary symbols required are in the basic AutoCAD DWG file as blocks.

Steps:

- With the first drawing, insert the PLC I/O symbol and edit addresses to match spreadsheet
- Insert the in-line device symbols with wires to connect symbols from the buses to the I/O points
- Cut/paste description and tag text over from the spreadsheet. Repeat until all modules are accounted.

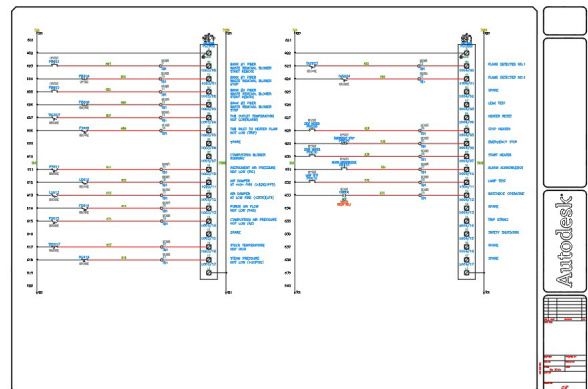
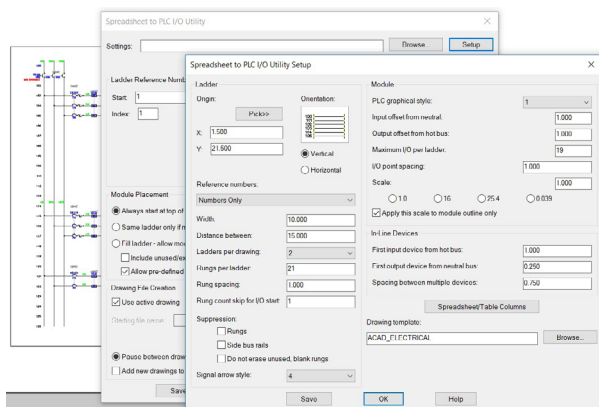

Automatically create PLC I/O drawings from spreadsheets	AutoCAD	Electrical toolset
Number of commands utilized	4	1
Number of times commands accessed	246	1
Number of user picks and clicks	448	6
Total time to complete task	122:00	0:41
Time savings with the Electrical toolset		99%

(Figures shown in minutes and seconds)

Advantages:

The Electrical toolset provides massive time savings when creating PLC I/O drawings as compared to basic AutoCAD, but with the following assumptions:

- The designer has created an initial control scheme in a suitable spreadsheet (Excel)
- The data is properly formatted
- The basic AutoCAD user has created the ladders in the drawings and is using suitable blocks for symbols



Design task 7

Create smart panel layout drawings

The Electrical toolset allows you to create physical footprint representations of your panel layouts in your project drawings. Users can choose the panel location and install a 'footprint' of panel components, which, in turn, are then linked back to the schematic component symbols in their schematic drawings.

In this task, the panel drawing includes a panel door layout created from schematic data, with nameplates added to each operator. Balloons are also added to the push buttons and switches. In basic AutoCAD,

it is assumed that all panel components are blocks in the drawing file.

Steps:

- Create a panel layout drawing, with a door to represent the panel door footprint
- Insert panel components to represent schematic push buttons and selector switches
- Add nameplates with descriptions for each panel door component
- Balloon each of the push buttons and the switch with the same balloon number as the parts list

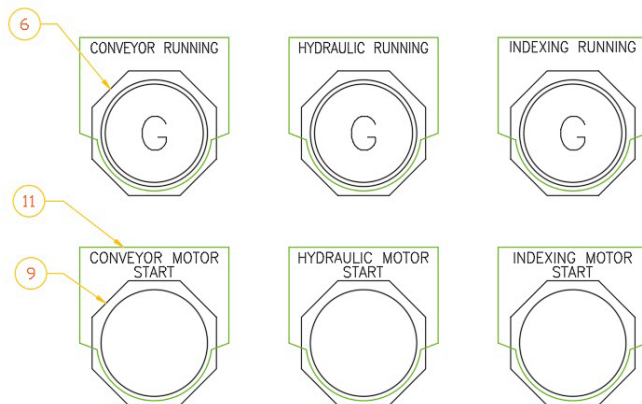

ITEM	QTY	CATALOG	MFG	DESCRIPTION
6	3	800H-PR16G	AB	GREEN PILOT LIGHT - STANDARD, ROUND DILTIGHT 30.5mm 120VAC, 1/2 MK PLASTIC LENS CORROSION RESISTANT
7	5	800H-PR16R	AB	RED PILOT LIGHT - STANDARD, ROUND DILTIGHT 30.5mm 120VAC, 1/2 MK PLASTIC LENS CORROSION RESISTANT
8	2	800MR-HH2BB	AB	SELECTOR SW - 2 PDS MAINT, NEMA 13 22.5mm BLACK KNOB 2 ND 2 NC QUICK CONNECT TERMS
9	3	800T-A2A	AB	PUSH BUTTON - MOMENTARY, NEMA 4/13 30.5mm FLUSH BLACK 1 ND 1 NC
10	3	800T-D1B	AB	PUSH BUTTON - MUSHROOM, NEMA 4/13 30.5mm GREEN 2 ND 2 NC
11	13	800T-X59E	AB	Name Plate 800T Half Round Gray Custom Text
12	3	800T-X701	AB	Name Plate 800T Automotive Red Blank

Create smart panel layout drawings	AutoCAD	Electrical toolset
Number of commands utilized	3	4
Number of times commands accessed	18	4
Number of user picks and clicks	210	77
Total time to complete task	6:29	2:33
Time savings with the Electrical toolset		61%

(Figures shown in minutes and seconds)

Advantages:

The time savings provided by the Electrical toolset are obvious when creating panel layout drawings:

- Part number assignments in schematic drawings can drive automatic panel footprint selection
- Tag-ID and description text from schematic symbols automatically copies to panel components
- Automatic tracking of item numbers for balloons and parts lists

Design task 8

Automatic project reports

With the data available in the Electrical toolset projects, the time taken to generate reports is drastically reduced. This includes Bill of Materials (BOM), cable lists, terminal reports, from data/to wire lists, and many more.

The task is to create a BOM for the current drawing in a project. The drawing includes several components used numerous times throughout the panel. The BOM will consist of tag numbers, quantity, manufacturer name, catalog number, and description.

Steps:

- Create table with required fields (BOM)
- Add component data to the table

TAGS	QTY	SUB	CATALOG	MPG	DESCRIPTION
CR495 CR496 CR497	3		700-P0004	AB	P TYPE ELECTRICALLY HELD RELAY, 4 POLE, AC COIL, CONVERTIBLE CONTACTS 120VAC 2 NO 125-120VAC 50HZ / 120VAC 50HZ COIL, RATING 10A, OPEN TYPE RELAY PAUL MOUNT
L5605 L5606 L5607	3		MS-50L	MS	
L1614 L1618 L1625	3		800H-P0160	AB	GREEN PILOT LIGHT - STANDARD, ROUND DILIGHT 30.5mm 120VAC 50HZ PLASTIC LENS CORROSION RESISTANT
L1608 L1610 L1611 L1612	4		800H-P0168	AB	RED PILOT LIGHT - STANDARD, ROUND DILIGHT 30.5mm 120VAC 50HZ PLASTIC LENS CORROSION RESISTANT
M613 M614 M615 M616 M617	5		ANS5ND03	EATON	
PR619	1	#1	800EP-E2	AB	RED BUTTON - MOMENTARY, SPAL, NORM 1/2X1/2 22.5mm EXTENDED, SEC STYLE BLACK 5 NO PLASTIC OPERATOR - 2 ADDRESS MTG
		#2	800E-EX03	AB	800E CONTACT BLOCK 22.5mm SEC STYLE 1 NO
		#3	800E-ASL	AB	800E MOUNTING LATCH - 2 ADDRESS
PR621 PR624	2		800T-ADA	AB	
PR613A PR613B PR624A	3		800T-BSB	AB	
S5605 S5606	2		800RH-14023	AB	
TS-B	4		8N-TL/2	AUTOMATION	
TS-A	5		8VAL 001-18F02	SIEMENS	
TS-B	3		8VAL 001-18F04	SIEMENS	

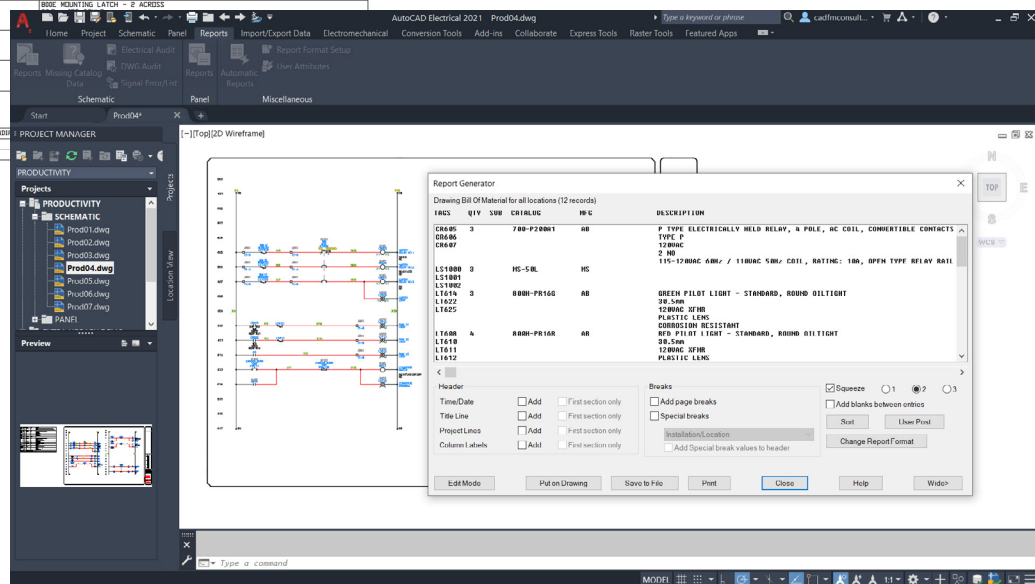

Automatic project reports	AutoCAD	Electrical toolset
Number of commands utilized	1	1
Number of times commands accessed	1	1
Number of user picks and clicks	694	8
Total time to complete task	9:28	0:18
Time savings with the Electrical toolset		97%

(Figures shown in minutes and seconds)

Advantages:

Using a basic AutoCAD table object helps with this task, but it does not remove the time-consuming process of collecting all the project data to go into the table nor does it avoid the chances of error. The Electrical toolset provides an incredible time-saving workflow and accuracy with:

- Part numbers assigned from pick lists with full descriptions
- The BOM that can be placed on the drawing, using project data, from the dialog box
- Minimal error with no mis-typed component tag names, quantities, and descriptions
- The searchable report feature that allows automatic location of a specific component by tag number, catalog number, or description in order to find the location on any project drawing

Design task 9

Share and track drawing changes

Your project drawings can be shared from the Electrical toolset to basic AutoCAD and AutoCAD LT. When changes are made in the drawings outside of the Electrical toolset, these changes can be tracked easily and reports generated to display the changes. You can also mark your new revisions to project drawings in this way. The task is to identify drawing changes, after a customer's modifications.

Steps:

- Run the Mark/Verify command on a project drawing set prior to releasing the drawings
- The customer will use basic AutoCAD to edit the drawing and make alterations to the design
- Once the drawings are back with you, create a list of the changes made by the customer to the drawing

The image shows a 'Mark/Verify Report' window on the left and an electrical schematic diagram on the right. The report window displays the following information:

```
REPORT: Changes made on this drawing since last Mark command  
  
Mark/Verify Report  
-- Dwg: C:\USERS\SHAUN_000\DOCUM... \DRAWINGS\PRODUCTIVITY\PROD04.DWG  
Marked date: 24/05/2018 19:09:59 by: SCB  
Verify date: 24/05/2018 19:11:59  
Changes in drawing Prod04.dwg  
changed -----  
LS1001  CHANGED Schematic component  old:LS996  
LS1002  CHANGED Schematic component  old:LS997  
LS1000  CHANGED Schematic component  old:LS995
```

The schematic diagram on the right shows three horizontal lines representing busbars, labeled 605, 606, and 607. Each busbar has a vertical line labeled 'JBOX1' and a switch labeled 'TS-A'. To the right of each switch is a red-bordered box containing the text 'RAM 01 RETRACTED LS1000', 'RAM 02 RETRACTED LS1001', and 'RAM 03 RETRACTED LS1002' respectively.

Share and track drawing changes	AutoCAD	Electrical toolset
Number of commands utilized	1	1
Number of times commands accessed	2	2
Number of user picks and clicks	37	12
Total time to complete task	5:36	0:48
Time savings with the Electrical toolset		86%

(Figures shown in minutes and seconds)

Advantages:

Basic AutoCAD does not have any reporting tools with which you can compare workflow in the same way as the Electrical toolset. But it does have DWG Compare and XREF Compare, which provide visual reviews of any changes. The benefits of the Mark/Verify command in the Electrical toolset are self-evident and reduce tedious drawing reviews that can lead to errors:

- Automatic tracking of drawing modifications
- Mark/Verify accepts changes from the Electrical toolset, basic AutoCAD, and AutoCAD LT
- Report generation of design revisions, creating a workflow/audit trail



Design task 10

Reuse existing drawings

External drawings can be brought into your Electrical toolset projects easily, with updating and re-tagging made very easy with the Update/Retag tool.

You can also reuse existing project drawings for a new project. The task is to take a small number of project-related schematic and panel layout drawings and copy them to a new project and update the drawing title blocks accordingly. This then provides large time savings when starting a new design using existing design data.

Steps:

- Copy each drawing to a new project folder and rename each filename
- Open each drawing and edit the project name, job number, and engineer attribute values on the title block to reference in the new project information

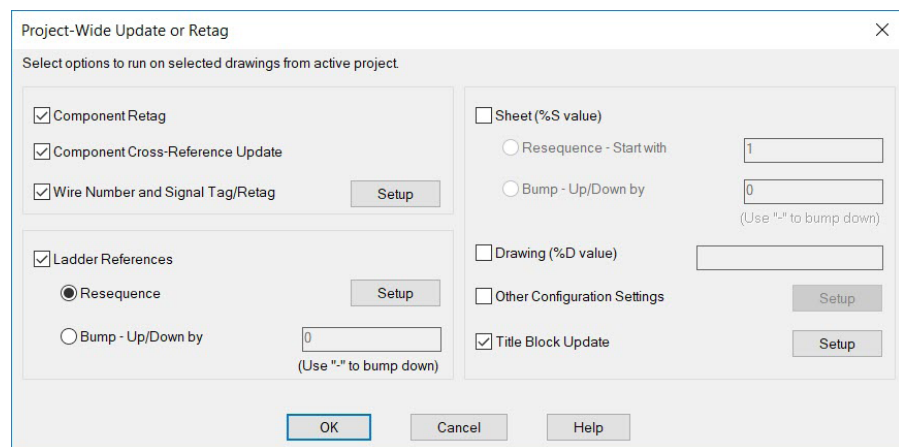
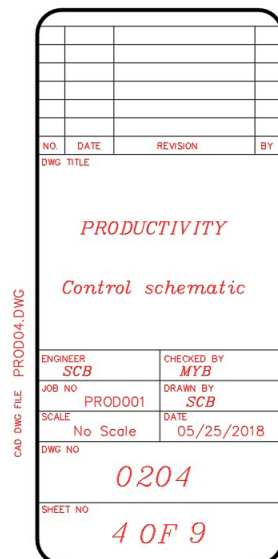

Reuse existing drawings	AutoCAD	Electrical toolset
Number of commands utilized	8	3
Number of times commands accessed	35	3
Number of user picks and clicks	275	61
Total time to complete task	6:43	1:18
Time savings with the Electrical toolset		81%

(Figures shown in minutes and seconds)

Advantages:

With the update and re-tagging tools in the Electrical toolset, you can automate the repetitive manual copying, pasting, and renaming that is required in basic AutoCAD. The workflow is highly customizable and provides the following advantages:

- Reduces repetitious and time-consuming renaming of DWG files in your projects
- As the project drawing count increases, so does the overall time savings in your Electrical toolset workflow

Conclusion

In this Electrical toolset productivity study, the ten design tasks analyzed were just a few examples of how the Electrical toolset can provide tools and workflows to make you more productive.

Based on these ten selected tasks, the Electrical toolset provides a level of productivity that is not possible with basic AutoCAD. Because the Electrical toolset is built specifically for electrical controls design, the software can allow electrical designers to realize immediate and substantial productivity gains, such as the tasks mentioned in this study.

Project tasks	AutoCAD	Electrical toolset	Time Savings
1. Comprehensive symbol libraries	1:50	0:16	85%
2. Automatic wire numbering and component tagging	1:50	0:20	82%
3. Real-time error checking	2:15	0:23	83%
4. Real-time coil and contact cross-referencing	1:55	0:26	77%
5. Electrical-specific drafting features	4:45	1:45	63%
6. Automatically create PLC I/O drawings from spreadsheets	122:00	0:41	99%
7. Create smart panel layouts	6:29	2:33	61%
8. Automatic project reports	9:28	0:18	97%
9. Share and track drawing changes	5:36	0:48	86%
10. Reuse existing drawings	6:43	1:18	81%
Total time	162:51	8:48	
Overall time savings with Electrical toolset			95%

(Figures shown in minutes and seconds)

The advantages of the Electrical toolset

Because the Electrical toolset is built specifically for electrical design, you could realize immediate productivity benefits such as the ones discussed in this paper.

*As with all performance tests, results may vary based on machine, operating system, filters, and even source material. While every effort has been made to make the tests as fair and objective as possible, your results may differ. Product information and specifications are subject to change without notice. Autodesk provides this information “as is”, without warranty of any kind, either express or implied.

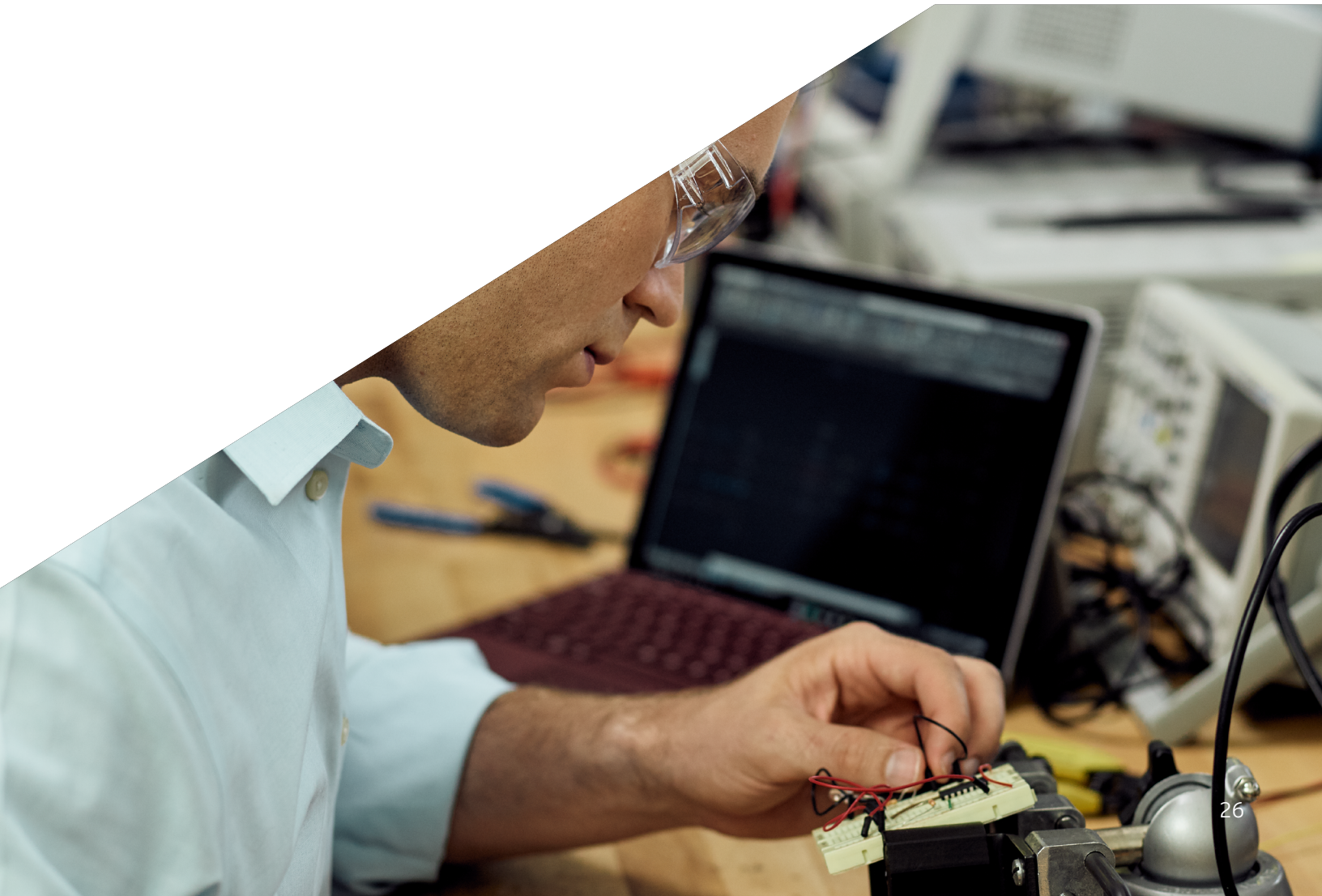



Autodesk is a registered trademark of Autodesk, Inc., and/or its subsidiaries and/or affiliates in the USA and/or other countries. All other brand names, product names, or trademarks belong to their respective holders. Autodesk reserves the right to alter product offerings, specifications and pricing at any time without notice, and is not responsible for typographical or graphical errors that may appear in this document.

© 2022 Autodesk, Inc. All rights reserved.